



BM-100A/B/C

TRANSCUTANEOUS JAUNDICE DETECTOR

Service Manual

TABLE OF CONTENTS

SECTION	PAGE
1. GENERAL INFORMATION	1-1
1.1 PREFACE.....	1-1
1.2 SAFETY MATTERS.....	1-1
1.3 ASSURANCE ASSERTION.....	1-1
1.4 SERVICE COMMITMENTS.....	1-3
1.5 SUPPLEMENTARY INSTRUCTIONS.....	1-3
1.6 PERIODIC SAFETY CHECK.....	1-4
2. PRODUCT INTRODUCTION.....	2-1
2.1 INTENDED USE.....	2-1
2.2 INTENDED USE ENVIRONMENT.....	2-1
2.3 CONTRAINDICATION.....	2-1
2.4 STRUCTURAL COMPOSITION.....	2-1
2.5 SYMBOLS.....	2-3
2.6 DEVICE PERFORMANCE.....	2-4
3. FUNCTION DESCRIPTION.....	3-1
3.1 OVERALL FUNCTION DESCRIPTION.....	3-1
3.2 DETECTION PRINCIPLE.....	3-1
3.3 ALARM INFORMATION AND SYSTEM FAILURE INFORMATION ...	3-2
4. INSTALLATION AND CHECKING PROCEDURE.....	4-1
4.1 UNPACKING.....	4-1
4.2 INSTALLATION.....	4-1
4.3 CHECKING PROCEDURE.....	4-5

SERVICE MANUAL FOR TRANSCUTANEOUS JAUNDICE DETECTOR

5. CLEANING DISINFECTION AND MAINTENANCE	5-1
5.1 CLEANING AND DISINFECTION	5-1
5.2 MAINTENANCE	5-2
6. REPLACEMENT OF PARTS	6-1
6.1 INTRODUCTION.....	6-1
6.2 REPLACEMENT OF PARTS	6-1
7. WIRING DIAGRAM	7-1
8. LIST AND NUMBER OF DEVICE'S MAIN PARTS	8-1
APPENDIX A: EMC INFORMATION.....	l
APPENDIX B: REPORT OF CLINICAL TRIAL RESULTS	i

NOTE: The product's appearances maybe differ from the one in this manual, but it does not affect the capability of product. Please understand if it brings you troubles.

SECTION 1

GENERAL INFORMATION

1.1 PREFACE

The manual is a guide for installation, debugging, maintenance and repair of BM-100A Transcutaneous Jaundice Detector (hereinafter referred to as jaundice detector) produced by the Company.

This manual is for trained and qualified maintenance personnel only. Instructions to the operator of the device are provided in a separate operator's manual.

1.2 SAFETY MATTERS

NOTE: For procedures or situations that may be overlooked or misunderstood, "Note" information should be added to draw enough attention. "Note" information may also be used to clarify facts that seem contradictory or confusing.

WARNING: "Warning" information is used to warn dangers or risks associated with operation, cleaning and maintenance of the device, and it may result in life-threatening or serious personal injury to the operator or patient if the user fails to follow the operating instructions highlighted in this way.

1.3 ASSURANCE ASSERTION

The products described in this manual are guaranteed for one year from the date of shipment if they are defective in materials and workmanship, but except for the following circumstances:

1) For all consumables, free warranty is provided for defects delivered only.

2) What confirmed as normal maintenance is not covered under the one-year warranty.

3) Damage caused by improper handling, such as damage caused during transportation or movement.

4) Damage caused by fires, earthquakes, floods and other natural disasters.

In addition to those listed above, any defective part can be replaced for the user free of charge within the warranty period.

WARNING
<p>The Company shall not be liable for any personal injury or property loss arised from any of the following situations:</p> <ol style="list-style-type: none">1. Any malfunction or damage caused by incorrect operation.2. Any malfunction or damage caused by the user maintaining the device without following the methods specified in this manual.3. Any malfunction or damage caused by use of the parts not designated by the Company during modification or maintenance.4. Any malfunction or damage caused by neglect of operation precautions or instructions specified in this manual.5. Any malfunction or damage caused by the operating environment, including electrical condition does not meet the requirements specified in this manual.6. Any malfunction or damage caused by maintenance by any unauthorized distributor/ maintenance service provider.7. Any malfunction or damage caused by ancillary devices that do not meet the safety requirements are used to this device, resulting in a reduction of the system's safety performance.8. Any malfunction or damage caused by thoughtless or improper modification.

WARNING: Any modifications to the device are not allowed.

The Company requires users to test the complete performance of the device before official use and to test it at least once every 12 months afterwards. It is suggested to attend the relevant training courses organized by the Company or the distributor authorized by the Company during the warranty period, so as to comply with this guideline.

To obtain relevant maintenance service information, contact your local dealer or the After-Sales Department of David Medical.

1.4 SERVICE COMMITMENTS

In order to ensure the best performance of the product, product maintenance must be carried out by authorized and qualified maintenance personnel. The user can contact the local agent authorized by our company or our company's after-sales service department for maintenance.

1.5 SUPPLEMENTARY INSTRUCTIONS

The Company adheres to constantly improving products, therefore, the improved circuits and parts are added to the product sometimes before it is edited in the Service Manual. Thus, it is possible that some of the parts used in your device are different from those in the parts list in this manual, but this does not affect the device performance. Whenever it happens, the instruction for change will be provided to you in separate sheets. Please understand if it is inconvenient for reading.

This manual contains all maintenance information. To ensure product safety and avoid danger, product maintenance and modification can only be carried out by authorized and qualified maintenance personnel. We cannot guarantee that the device can operate normally through the repair of unauthorized maintenance personnel.

The service life of the jaundice detector is 6 years. The jaundice detector and its accessories, if discarded casually after expiry, will cause damage to the local environment, so the detector must be disposed of in accordance with local laws or returned to the Company for disposal.

1.6 PERIODIC SAFETY CHECK

The following safety checks should be carried out by a trained professional with sufficient knowledge and practical experience at least once every 12 months, and the check data should be kept.

- ① Check the mechanical structure and functional integrity of the device.
- ② Check if the symbols and marks listed in this manual are clear and distinguishable.
- ③ Check if the performance index of the device is consistent with the values alleged in Section 2.6.
- ④ Test the leakage current of the device's housing as per the test method specified in IEC 60601-1:2005+A1: 2012, and the current shall not exceed 100 μ A in normal state; it shall not exceed 500 μ A in single failure state.
- ⑤ Test the patient leakage current of the device as per the test method specified in IEC 60601-1:2005+A1: 2012, and the alternating current shall not exceed 100 μ A in normal state; the direct current shall not exceed 10 μ A.

- ⑥ Test the patient leakage current of the device as per the test method specified in IEC 60601-1:2005+A1: 2012, and the alternating current shall not exceed 500 μ A in single failure state; the direct current shall not exceed 50 μ A.
- ⑦ Test the patient leakage current of the device (Add grid voltage to the applied part) as per the test method specified in IEC 60601-1:2005+A1: 2012, and the current shall not exceed 5000 μ A in single failure state.

SECTION 2

PRODUCT INTRODUCTION

2.1 INTENDED USE

This device is used to estimate the serum bilirubin levels of neonates before, during and after phototherapy.

2.2 INTENDED USE ENVIRONMENT

The device is intended to be used in: Medical institutions with practice license (e.g. hospitals). Specific operating environments include: Neonatology Dept., Pediatric Dept., Maternity and Child Care Centers, delivery rooms, infant wards and neonatal intensive care units.

2.3 CONTRAINDICATION

It is not clear yet.

2.4 STRUCTURAL COMPOSITION

The jaundice detector consists of a host, a base and a power adapter. The host is composed of optical probe, display screen, battery and host circuit. The base can be used to charge the host and contains a check screen. The optical probe is the application part, the head is composed of polymer fiber arrangement, and the contact part of the end is made of PMMA. The spectrum application range of the optical probe is 350nm and 700nm. The spectral response peak is 550nm. The pulse duration of this product is 3ms and the pulse interval is greater than 2s.

SERVICE MANUAL FOR TRANSCUTANEOUS JAUNDICE DETECTOR

2.4.1 HOST

Switch

Long press the switch to set the host to ON/OFF

Ready indicator light

The device is ready for the next measurement when the green light is on.

Display screen

Display measurements and error messages, etc. Select and confirm by touching screen.

Optical probe

Start measuring by attaching the optical probe to the measuring point.

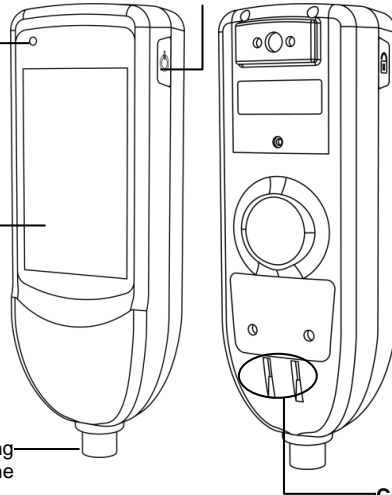

Contact for charging

Connecting the base during charging.

2.4.2 BASE

Charging terminal

Connecting the host when charging.

Base indicator light

Indicate the base state.

Inspection screen

For inspection of the device.

Inspection screen cover

Please open the cover upon inspection.

DC interface

Connecting the power adapter.

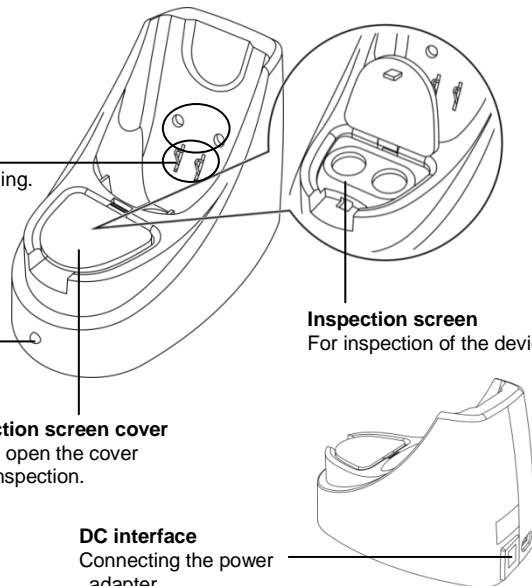

SERVICE MANUAL FOR TRANSCUTANEOUS JAUNDICE DETECTOR

2.4.3 POWER ADAPTER

Power plug

Connecting to a power outlet.

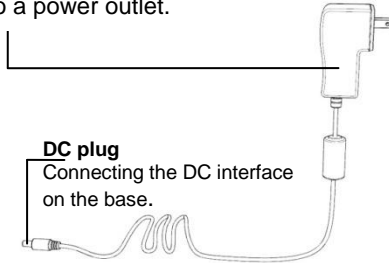











DC plug



Connecting the DC interface on the base.

2.5 SYMBOLS

2.5.1 SYMBOLS ON THE HOST



	Stand-by		Unlock/lock screen symbol
	Type BF applied part	Ready	Ready indicator light symbol
	Serial number		Date of manufacture
	Refer to instruction manual/booklet		Direct current
	CE MARKING		European union representative
	Manufacturer		

2.5.2 SYMBOLS ON THE BASE

	General warning sign	0	Inspection screen with predetermined value "0"
20	Inspection screen with predetermined value "20"		Serial number
	Date of manufacture		

SERVICE MANUAL FOR TRANSCUTANEOUS JAUNDICE DETECTOR

2.5.3 SYMBOLS ON THE POWER ADAPTER

	General warning sign		Class II device
---	----------------------	---	-----------------

2.6 DEVICE PERFORMANCE

Classification according to the type of protection against electric shock:
 Class II, internal power supply device.

Classification according to the degree of protection against electric shock:
 Type BF applied part.

Not AP or APG device.

Classification according to operational mode: Continuous operation.

General parameters

Intended users Neonates

Requirements of operating environment Temperature: 5°C-40°C;

Humidity: ≤90%RH;

Atmospheric pressure: 700hPa-1060hPa

Requirements of transportation and storage environment.....Temperature: -20-55°C;

Humidity: ≤90%RH;

Atmospheric pressure: 500hPa-1060hPa;

It should be stored in a ventilated and dry storehouse; it should be prevented from rain, water immersion, sun exposure, fall and mechanical losses during transportation; it shall not be stored or transported together with poisonous, harmful or corrosive substances

SERVICE MANUAL FOR TRANSCUTANEOUS JAUNDICE DETECTOR

Liquid ingress protection grade	IPX0
Host weight	≤ 250g
Host size	60mm×41mm×175mm
Base weight.....	≤ 250g
Base size.....	85mm×155mm×106mm
Expected service life	6 years
Applied environmental altitude	≤3000m
Pollution level.....	2

Performance parameters

Maximum display value.....	No less than 25.0 mg/dL (425µmol/L)
Accuracy.....	± 1.5 mg/dL (± 25.5 µmol/L)
Repeatability.....	No more than 3%
Information prompt.....	Low voltage prompt
Inspection screen	The transmittance ratio of the spectra with wavelength of 550nm and 461nm is: The inspection screen with predetermined value of "0" is 1±0.1 The inspection screen with a predetermined value of "20" is 5±0.5;
Average measurement function.....	1 ~ 5 times average measurement can be set
Set the time	Time and date modifications can be implemented
Sound Settings.....	Touch screen key tone can be set to on/off
Brightness Settings	The brightness of the screen can be adjusted by 5 levels
Unit of measure	The unit of measurement can be switched between mg/dL and µmol/L
The screen saver	Screen saver time can be set to 1 minute or 5 minutes

SERVICE MANUAL FOR TRANSCUTANEOUS JAUNDICE DETECTOR

Historical data saving.....Nurse ID number, baby ID number, measurement result, measurement time, measurement is priority, blue light completion mark can be saved

Other parameters

Rated voltage and frequency of the device when it is supplied by the supply main:

AC 100-240V, 50/60Hz

Input power of the device when it is supplied by the supply main.....30 VA

Power supply type of the host when it is supplied by the internal power:

Rated voltage 7.4V  (lithium battery)

Base output 8.4V  1A

Light source.....Xenon flash lamp

Light source life Not less than 150000 times

Other The base has a built-in inspection screen

The optical radiation parameters are shown in the table below:

Maximum output of optical radiation

Radiance Output	Risk group classified by IEC60601-2-57:2011	Maxi value
Euva: Eye UV-A	Exempt Group	$6.28 \times 10^{-6} \text{ W} \cdot \text{m}^{-2}$
ES: Actinic UV skin & eye	Exempt Group	$8.02 \times 10^{-6} \text{ W} \cdot \text{m}^{-2}$
EIR: Infrared radiation hazard exposure limits for the eye	Exempt Group	$5.89 \times 10^{-1} \text{ W} \cdot \text{m}^{-2}$
LB: Blue light	Exempt Group	$4.03 \times 10^{-3} \text{ W} \cdot \text{m}^{-2} \cdot \text{sr}^{-1}$
LR: Retinal thermal	Exempt Group	$8.49 \times 10^{-1} \text{ W} \cdot \text{m}^{-2} \cdot \text{sr}^{-1}$

SECTION 3

FUNCTION DESCRIPTION

3.1 OVERALL FUNCTION DESCRIPTION

The jaundice detector is a device used to dynamically detect the transcutaneous value of neonatal serum bilirubin, which applies optical fiber technology, optical technology, electronic and information processing technologies to quickly and non-invasively determine the transcutaneous bilirubin value related to serum bilirubin concentration on the neonatal skin outer epidermis.

3.2 DETECTION PRINCIPLE

Serum bilirubin builds up in the skin tissue, making the skin yellow. The jaundice detector uses the absorption difference between blue light waves (461nm) and green light waves (550nm) in the skin tissue to detect the concentration of bilirubin deposited in the neonatal skin tissue.

After the probe is placed on the infant's forehead and powered up, the ray emitted from the xenon flash lamp is guided to skin surface via the light-guide fiber of the probe's outer ring and directly to the subcutaneous area. The light waves are repeatedly scattered and absorbed on the skin, and finally returned to the light-guide fiber of the probe's inner ring, and transmitted to the corresponding photodiode. The measured value (also known as the transcutaneous value) of the jaundice detector is obtained by calculating the optical density difference between light waves of 461nm and 550nm.

The transcutaneous value, demonstrated by clinical trials, has a good linear correlation with neonatal serum bilirubin concentration, which means that a certain transcutaneous value corresponds to a certain concentration of serum bilirubin. The level and change of serum bilirubin concentration, therefore, can be determined according to the transcutaneous value and its change, especially the change of serum bilirubin concentration can be accurately reflected, so as to effectively detect neonatal jaundice.

NOTE: DO NOT press the measuring probe when it is pointed toward the eyes.

3.3 ALARM INFORMATION AND SYSTEM FAILURE INFORMATION

The screen may display the following warnings.

Please process according to the failure information.

3.3.1 BATTERY POWER DISPLAY

Battery symbol and action	Cause	Solution
 Battery symbol lights up	It may be charged insufficiently.	The measurement can be continued after the warning is shown the first time, but we suggest charging the battery as soon as possible.

3.3.2 OTHERS

Display (errors)	Cause	Solution
Er1 (measurement error)	The measured value is out of display range.	Please place the probe vertically at the recommended point (forehead or sternum) and measure again

SECTION 4

INSTALLATION AND CHECKING PROCEDURE

4.1 UNPACKING

The jaundice detector is generally packed in a carton. It shall be handled with care when unpacking to avoid damaging parts or accessories.

Please check for the following items.

- | | |
|----------------------|----|
| 1) Host | x1 |
| 2) Base | x1 |
| 3) Power adapter | x1 |
| 4) Operator's manual | x1 |

4.2 INSTALLATION

Please follow the procedure given below, so as to ensure that the following measurements can be carried out stably.

4.2.1 CHARGING

NOTE: Please make sure that the battery has been fully charged at the first time to use.

SERVICE MANUAL FOR TRANSCUTANEOUS JAUNDICE DETECTOR

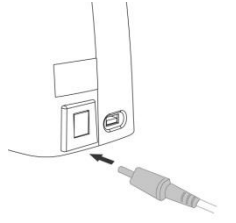
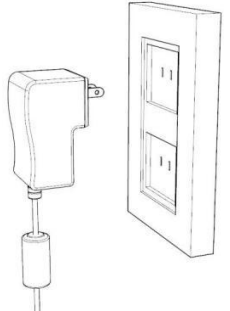
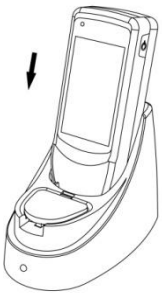





<p>① Connect the DC plug of the power adapter to the DC interface on the base.</p>	
<p>② Connect the power plug of the power adapter to the power outlet and the base green indicator light lights up.</p>	
<p>③ Place the device on the base.</p> <p>Please place the display screen towards you as shown in the figure. The base yellow indicator lights up when the device is properly placed on the base.</p> <p>If the initial setting is not conducted when the device power is set to ON for the first time, it will take about 4 hours to complete charging.</p> <p>The base green indicator lights up when the battery is fully charged.</p>	

4.2.2 SETTINGS

The measuring conditions and the device settings are preset.

Follow the following steps when changes are required.

SERVICE MANUAL FOR TRANSCUTANEOUS JAUNDICE DETECTOR

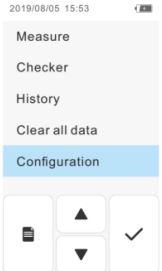
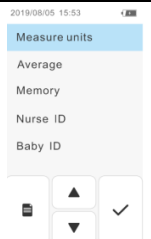
<p>① Press the power switch for more than 5 seconds to set the power to ON.</p>	
<p>② Select "Configuration" on the menu screen after pressing  button on the screen. Press  or  button to move the highlighted cursor over "Configuration", then press  button. You can also select by directly pressing the highlighted "Configuration" instead of  button. Display the setting screen.</p>	
<p>③ Select the items you want to change in sequence on the setting screen, and then set them separately.</p>	

Items that can be set up and related descriptions are as follows:

Setting Screen Item	Description	Setting Content	Description
Measure units	Set the unit displayed during measurement	mg/dL ● μmol/L	
Average	Set the number of times when the average measurement is carried out.	1 ● 2 3 4 5	

SERVICE MANUAL FOR TRANSCUTANEOUS JAUNDICE DETECTOR

Memory	Set whether the measured data is saved in the host or not.	Off ●	Not save measurement results in the host
		Memory only	Save the measurement results in the host
Nurse ID	Select the standard input method for the nurse ID	None ●	Not enter nurse ID
		Touch input	Enter ID via touch input
Baby ID	Select the standard input method for the baby ID	Touch input ●	Enter ID via touch input
Buzzer	Set the sound	Off ●	Silent
		On	Make a sound when touching, etc.
Time setting	Set date and time		

SERVICE MANUAL FOR TRANSCUTANEOUS JAUNDICE DETECTOR

Brightness	Change the screen contrast	1 ● 2 3 4 5	The smaller the value is, the darker the screen turns.
Screen saver time	Set the screen saver time	1 min ● 5 min	
Software version	Display the software version		
Initialization	Initialize the host's settings.		
<p>NOTE: "●" indicates the preset initial setting value when the power is turned ON for the first time and initialization is performed.</p>			

4.3 CHECKING PROCEDURE

The user should execute the following operation checking procedure before each use. If the device is used immediately without any inspection, the existing failures may not be found, leading to potentially unfavourable consequences.

The specific distance between the user and the device shall be subject to the comfort level during operation.

4.3.1 CHECK THE INTEGRITY OF THE DEVICE

- Confirm that the device is cleaned;
- Confirm that the device is free of cracks;

SERVICE MANUAL FOR TRANSCUTANEOUS JAUNDICE DETECTOR

- Confirm that all required parts and auxiliary equipments are available any time and in good order;
- Confirm that the electric wire is properly connected and the installation is secure.

WARNING: Once a certain function of the device is found missing or the housing is damaged, stop using it immediately, and it should be repaired by the qualified personnel.

4.3.2 USAGE OF THE INSPECTION SCREEN

NOTE

1. DO NOT touch the surface of the inspection screen with fingers. If the inspection screen becomes dirty, wipe it first with a soft cloth dampened with water and then with a dry cloth.
2. If the result is not within the reference range, please measure again after cleaning the inspection screen and the measuring probe.
3. If the result is still not within the range, please contact our company and designated agent for more detailed guidance.

Follow the following steps to use the inspection screen:

① Set the power to ON by pressing and holding the power switch for over 5 seconds.

About 1 year after purchase or calibration through the manufacturer's service, a "Please calibrate regularly" interface pops up. This is to suggest and inform you to perform a periodic calibration once a year for the device. If you need to entrust the calibration, please contact our company or authorized maintenance agency. Press the button below the interface to exit the interface.

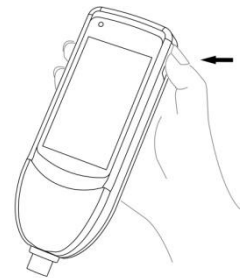

SERVICE MANUAL FOR TRANSCUTANEOUS JAUNDICE DETECTOR

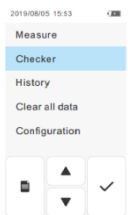
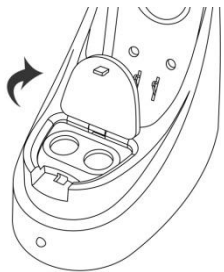
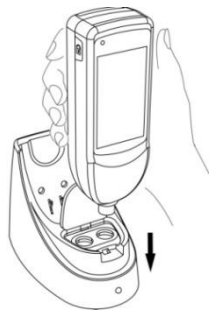
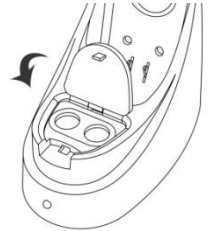
<p>② Select "Checker" on the menu screen.</p>	
<p>③ Open the inspection screen cover.</p>	
<p>④ Place the optical probe vertically on the inspection screen and gently push until it glows. If the measuring probe is not vertical to the inspection screen at contact, please place it vertically and measure again.</p>	
<p>⑤ Confirm the measured value. Reference range is 0.0-1.5 for white screen Reference range is 20.0 ± 1.5 for yellow screen</p>	
<p>⑥ Close the inspection screen cover.</p>	

SECTION 5

CLEANING, DISINFECTION AND MAINTENANCE

5.1 CLEANING AND DISINFECTION

Optical probe: After each newborn is measured, the equipment is first cleaned by dipping a small amount of cold or warm water with a damp flexible cloth, or with a neutral cleaning solvent or solution approved by the state. After cleaning, wipe the residual moisture on the dry surface with a clean soft cloth or absorbent paper towel, and then wipe and disinfect the optical probe with a flexible cloth dampened with 75% alcohol (more than three times is recommended).

Host, Base: Use a damp flexible cloth dipped in a small amount of cold or warm water, or a neutral cleaning solvent or solution approved by the state to clean the equipment. After cleaning, wipe the residual moisture on the surface of the dry equipment with a clean soft cloth or absorbent paper towel to avoid residue attachment on charging terminals (if residue attachment on charging terminals, etc., will lead to poor charging). Then dip in with 75% alcohol flexible cloth to host, base for wiping disinfection. Under normal circumstances, the host and base should be cleaned and disinfected once or twice a week. Do not use other methods or solvents.

DO NOT clean the device with diluent or benzene and other solvents, because these solvents may dissolve the housing.

5.2 MAINTENANCE

5.2.1 ROUTINE MAINTENANCE

The testing shall be carried out by a trained professional with sufficient knowledge and practical experience at least every 12 months, the testing data shall be kept, and the inspection contents are as follows:

A. Inspection of related files:

Operator's manual is available

B. Perform functional tests on the following features as per the manual:

Optical measurement

Internal battery

C. Inspect that the device combination is in good condition:

All labels are complete and legible

No visible damage on the device or power cords

D. Inspect that all parts and accessories used to run the device are available according to the operator's manual.

E. Carry out electrical safety inspection as per IEC 60601-1:2005+A1: 2012.

5.2.2 PREVENTIVE MAINTENANCE

The device shall be charged every 15 days if it is not used for a long time. The battery charger shall meet the requirements of IEC 60601-1:2005+A1: 2012.

The battery shall be replaced by the professional maintenance personnel at least every 24 months. B1 and J6 marks can be seen on the circuit board of the host when the device housing is opened with a tool, where B1 is button battery interface and J6 is power battery interface.

If the device cannot be turned on normally, while the charging indicator light is normal when the device is placed on the base, but the device still cannot be turned on normally after charging for 2-4 hours. This situation may be caused by over-discharge of the internal battery of the device. At this time, battery activation can be performed by applying an external voltage of 6V to the device charging contacts. This operation may require relevant professionals and related equipment. The specific activation connection method is shown in Figure 5.1. If there is no related equipment, you can also prepare two CR1220 button batteries (voltage 3V) and two office clips. As shown in Figure 5.2, connect the positive electrode of one button battery to the negative electrode of the other battery (the side marked with "+" on the button battery is positive and the other side is negative), in order to achieve a voltage output of 6V. Using the unfolded office clip as a wire, apply this 6V voltage to the charging contact of the device to activate the battery. The specific activation connection method is shown in Figure 5.2.

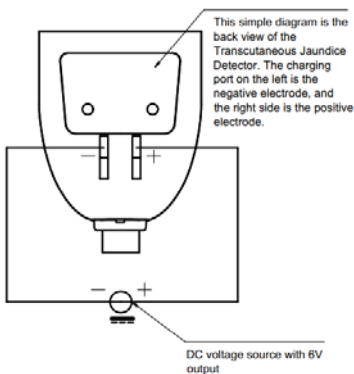

Figure 5.1

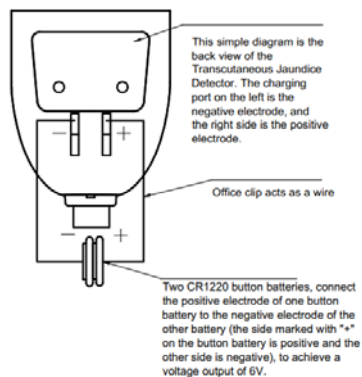

Figure 5.2

NOTE: Device failures can be caused by part wear and material fatigue.

WARNING

1. Disconnect all power supplies before performing any maintenance work.

2. Replacing the battery by an inadequately trained person can cause danger (such as over temperature, fire or explosion).

5.2.3 CALIBRATION

The standard inspection screen must be calibrated at least once annually. The transmittance ratio of spectrums with wavelengths of 550 nm and 461 nm shall be: The inspection screen with predetermined value "0" is 1 ± 0.1 ; the inspection screen with predetermined value "20" is 5 ± 0.5 .

The device shall be calibrated every 12 months. It shall be returned to the authorized maintenance center. The validity of initial calibration is within one year from the date of manufacture. The validity of subsequent calibration shall be within one year from the previous calibration date.

SECTION 6

REPLACEMENT OF PARTS

6.1 INTRODUCTION

This section provides the replacement of parts in display screen, optical probe, internal rechargeable battery and inspection screen.

6.2 REPLACEMENT OF PARTS

WARNING
1. Disconnect all power supplies before performing any part replacement.
2. The capacitance must be discharged first after opening the device housing.
3. The internal rechargeable battery shall be replaced after being used for 24 months.
4. DO NOT throw the replaced batteries in fire or water to avoid explosion or leakage.
5. The replaced batteries shall not be discarded casually, and they must be disposed of according to national law and regulations.
6. Replacement of parts shall be carried out by authorized and qualified maintenance personnel.

6.2.1 REPLACEMENT OF DISPLAY SCREEN

① Open the host housing, disconnect the connecting wire of display screen;

② Unscrew the fixing screw of display screen, take out the display screen and replace it.

6.2.2 REPLACEMENT OF OPTICAL PROBE

- ① Open the host housing, disconnect the lead of optical probe;
- ② Unscrew the fixing screw of optical probe, take out the optical probe and replace it.

6.2.3 REPLACEMENT OF INTERNAL RECHARGEABLE BATTERY

- ① Open the host housing, disconnect the lead of internal rechargeable battery and replace it.

6.2.4 REPLACEMENT OF INSPECTION SCREEN

- ① Removal washer;
- ② Replace the inspection screen, fix with new press washer and clean.

6.2.5 OTHERS

The parts mentioned in this section can be replaced after opening the device housing and unscrewing the corresponding fixing screws.

The parts include: Upper housing, lower housing, switch keycap, lock screen keycap, end face buckle, battery holder, base, base rubber base plate, base cover, corner fixator and base light.

SECTION 7. WIRING DIAGRAM

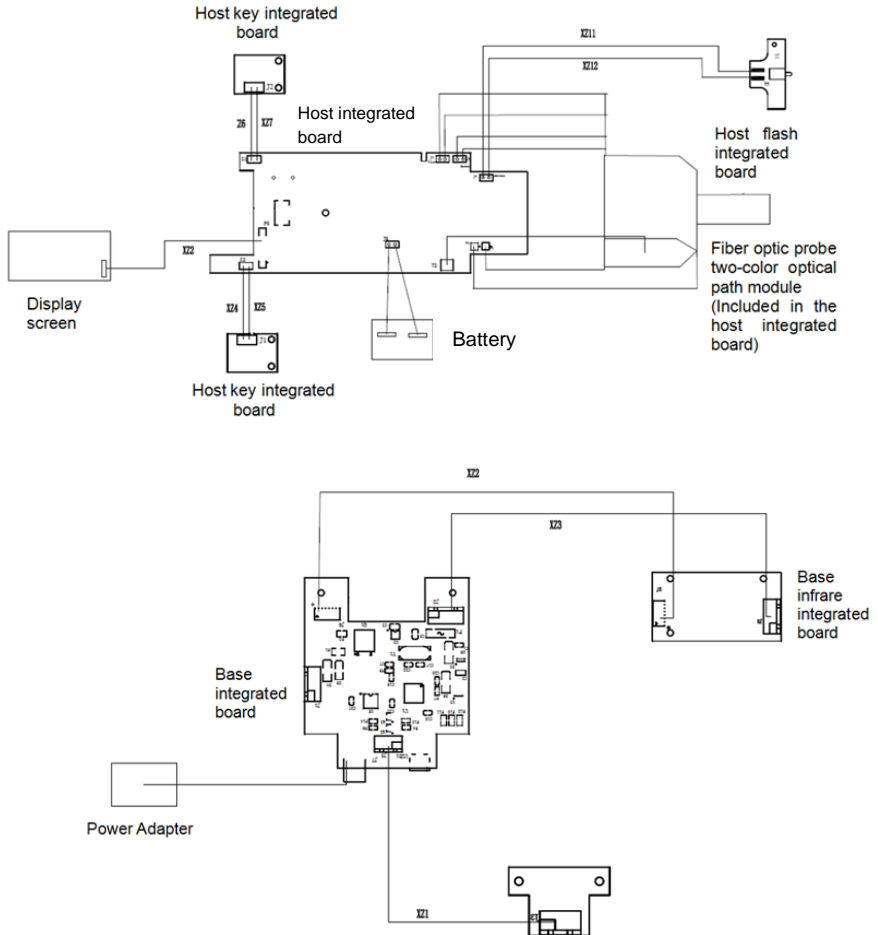

SERVICE MANUAL FOR TRANSCUTANEOUS JAUNDICE DETECTOR

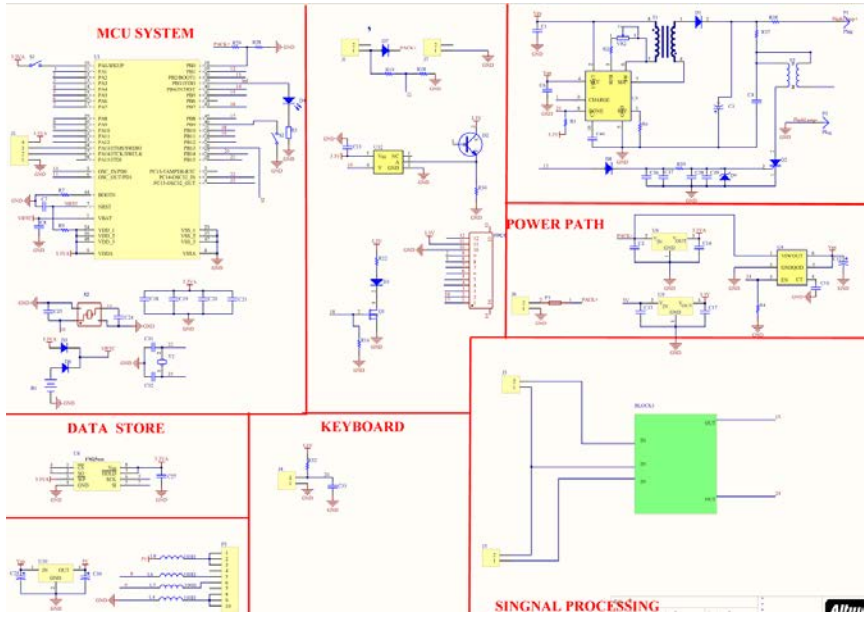

Host circuit board

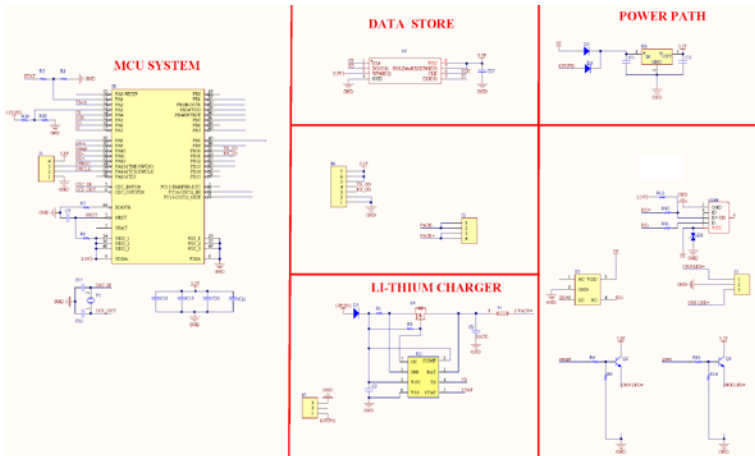

Base circuit board

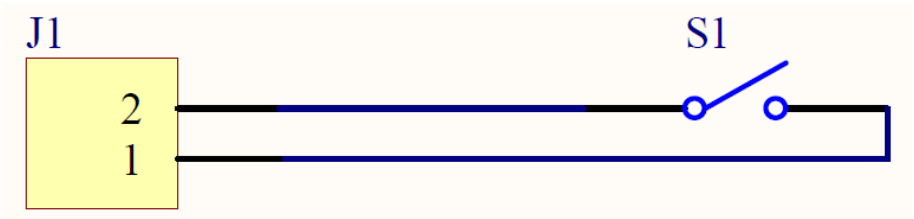

Key switch circuit board

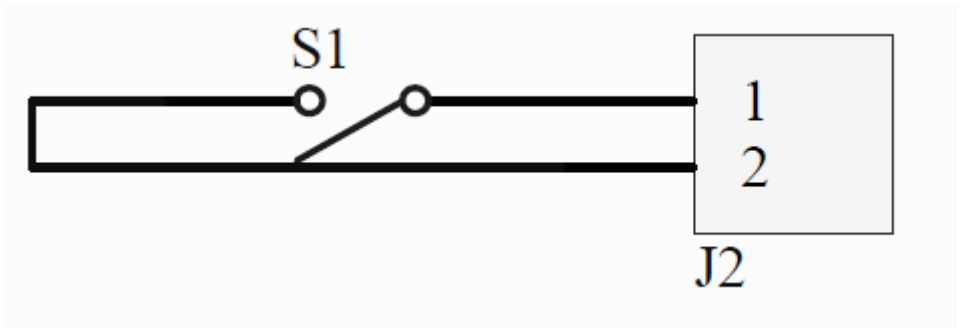

Flash switch circuit board

SECTION 8

LIST AND NUMBER OF DEVICE'S MAIN PARTS

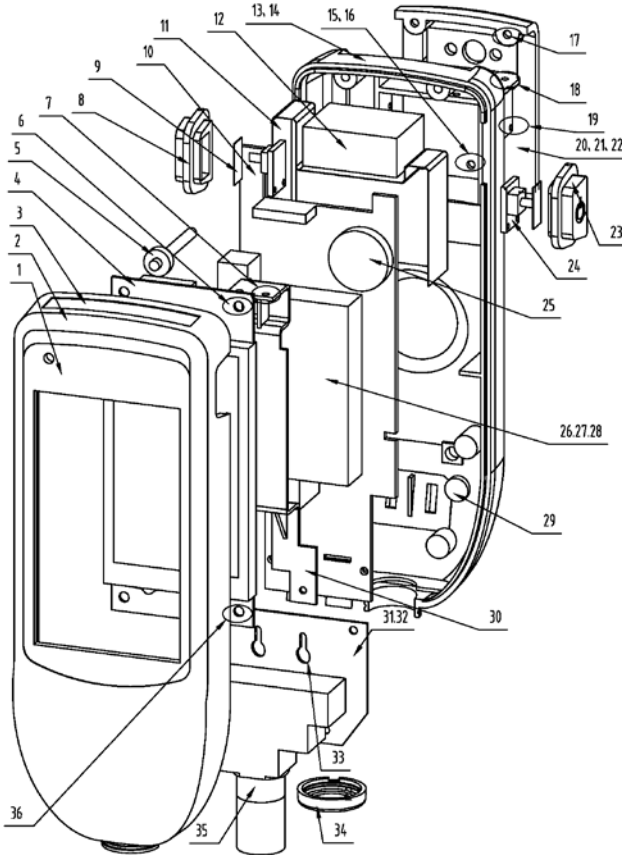

 SERVICE MANUAL FOR TRANSCUTANEOUS JAUNDICE DETECTOR

NO.	Name	Parts coding
1	Panel label	P3.01.003
2	Upper housing	P5.01.003
3	Serial number and production date label	P5.01.074
4	Display screen	86.21.060
5	Light pipe	P5.01.014
6	Pan head screws with cross recess	86.01.257
7	Pan head screws with cross recess	86.01.255
8	Lock screen keycap	P5.01.007
9	Gasket assembly	P5.01.024
10	Host integrated board	P5.01.016
11	Main program version number label	P5.01.082
12	Plastic shell	P5.01.023
13	Lower housing	P5.01.004
14	Electrical nameplate	P3.01.006
15	Pan head nylon screws with cross recess	86.22.233
16	Nylon nut	86.22.235
17	Pan head screws with cross recess	86.01.066
18	Hexagonal nut	86.02.040
19	Lower housing cover	P5.01.005
20	Note labels	P5.01.065
21	Switch keycap	P5.01.006
22	Battery	86.18.070
23	Battery	86.18.071
24	Battery label	P5.01.080

SERVICE MANUAL FOR TRANSCUTANEOUS JAUNDICE DETECTOR

NO.	Name	Parts coding
25	Sponge packaging	P5.01.015
26	Pan head screws with cross recess	86.01.256
27	Battery retainer	P5.01.012
28	Trigger the fixture assembly	P5.01.009
29	Host flash integrated board	P5.01.021
30	Small spring with hook	P5.01.013
31	End buckle	P5.01.008
32	Blank label	P5.01.093
33	Flat washer	86.44.435
34	Host key integrated board	P5.01.017

SERVICE MANUAL FOR TRANSCUTANEOUS JAUNDICE DETECTOR

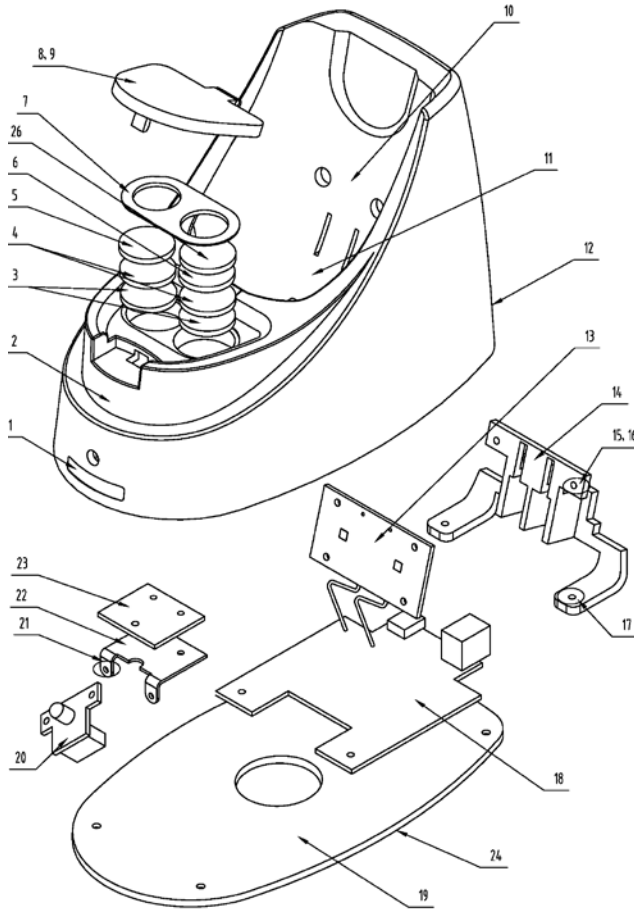

NO.	Name	Parts coding
1	Indicator light label	P5.01.089
2	Base	P5.01.026
3	Inspection screen black gasket	P5.01.033
4	Inspection screen white gasket	P5.01.032
5	0 value inspection screen diaphragm	P5.01.034
6	20 value inspection screen diaphragm	P5.01.031

SERVICE MANUAL FOR TRANSCUTANEOUS JAUNDICE DETECTOR

NO.	Name	Parts coding
7	Pressure washer	P5.01.030
8	Base cover	P5.01.028
9	Range value label	P5.01.092
10	Black label	P5.01.070
11	Output label	P5.01.086
12	Base label	P5.01.073
13	Base infrared integrated board	P5.01.037
14	Corner fixator	P5.01.029
15	Pan head nylon screws with cross recess	86.22.234
16	Nylon nut	86.22.235
17	Pan head screws with cross recess	86.01.258
18	Base integrated board	P5.01.035
19	Base rubber base plate	P5.01.027
20	Base LED integrated board	P5.01.040
21	Hexagonal nut	86.44.330
22	Lamp fixture B	P5.01.043
23	Lamp fixture assembly A	P5.01.095
24	Serial number and production date label	P5.01.074
25	Base wiring diagram	P5.01.051
26	Blue inspection screen diaphragm	P5.01.108

APPENDIX A: EMC INFORMATION

This section is precaution for electromagnetic compatibility. The device shall be installed, operated and used according to the electromagnetic compatibility information specified in this section.

A.1 Environmental Conditions of Electromagnetic Compatibility

1. The equipment intend to use in the professional healthcare facility environment.

2. Equipment cannot be operated or exposed in RFID, X-RAY, MRI environments.

3. Portable RF communication equipment (including peripherals such as antenna cables and external antennas) should be used no closer than 30 cm (12 inches) to any part of the equipment, including cables specified by the manufacturer. Otherwise, degradation of the performance of this equipment could result.

4. Equipment should not be used adjacent to or stacked with other equipment and that if adjacent or stacked use is necessary, the equipment should be observed to verify normal operation in the configuration in which it will be used.

5. If the essential performance is lost or degraded due to EMC disturbances, the user might need to take mitigation measures, such as relocating or re-orienting the equipment.

A.2 Classification of Electromagnetic Interference:

Group 1, Class A

A.3 Cable List Provided by the Manufacturer

Name	Cable length	Shielded or not	Manufacturer
Power cord	1.4 m	No	Taiwan Sinpro Electronics Co., Ltd.

A.4 EMC Immunity Performance Test (essential performance)

The deviation of bilirubin measurement is less than $\pm 1.5\text{mg/dL}$.

A.5 Warning

1. Pay attention to the electromagnetic environment at the scene, because the equipment may be affected by the electromagnetic environment at the scene.

2. Use of cables other than those specified or provided by the manufacturer of this equipment could result in increased electromagnetic emissions or decreased electromagnetic immunity of this equipment and result in improper operation.

Guidelines and Manufacturer's Declaration - Electromagnetic Emission

Guidelines and Manufacturer's declaration - Electromagnetic Emission	
<p>The <i>Jaundice Detector</i> is intended for use in the electromagnetic environment specified below. The customer of the user of the <i>Jaundice Detector</i> should assure that it is used in such and environment.</p>	
Emission Test	Conformance
RF emission CISPR 11	Group 1
RF emission CISPR 11	Class A
Harmonic emission IEC61000-3-2	Class A
Voltage fluctuation/scintillation emission IEC61000-3-3	Conform
<p>NOTE: The Emissions characteristics of this equipment make it suitable for use in industrial areas and hospitals (CISPR 11 class A). If it is used in a residential environment (for which CISPR 11 class B is normally required) this equipment might not offer adequate protection to radio-frequency communication services. The user might need to take mitigation measures, such as relocating or re-orienting the equipment.</p>	

Guidelines and Manufacturer's Declaration - Electromagnetic Immunity

Guidelines and Manufacturer's declaration - Electromagnetic Immunity		
<p>The <i>Jaundice Detector</i> is expected to be used in the following specified electromagnetic environment, and the purchaser or user shall ensure that it is used in this electromagnetic environment:</p>		
Immunity Test	IEC60601 Test Electrical Level	Compliance Level
Electrostatic discharge IEC 61000-4-2	±8 kV contact ±15 kV air	±8 kV contact ±15 kV air
Electrical fast transient burst IEC 61000-4-4	±2 kV for power supply lines ±1kV for signal input/output	±2kV for power supply lines ±1kV for signal input/output
Surge IEC 61000-4-5	±1 kV differential mode ±2 kV common mode	±1 kV differential mode
Voltage dips, short interruptions and voltage variations on the power input line IEC 61000-4-11	0 % U_T ; 0,5 cycle At 0°, 45°, 90°, 135°, 180°, 225°, 270° and 315° 0 % U_T ; 1 cycle and 70 % U_T ; 25 cycles Single phase: at 0° 0 % U_T ; 250cycle	0 % U_T ; 0,5 cycle At 0°, 45°, 90°, 135°, 180°, 225°, 270° and 315° 0 % U_T ; 1 cycle and 70 % U_T ; 25 cycles Single phase: at 0° 0 % U_T ; 250 cycle
Power frequency magnetic field(50 Hz) IEC 61000-4-8	30A/m	30A/m
NOTE: U_T is the a.c. mains voltage prior to application of the test level.		

Guidance and Manufacturer’s Declaration – Electromagnetic Immunity –for Equipment and Systems that are Life-Supporting

Guidance and manufacture’s declaration – electromagnetic immunity		
<p>The <i>Jaundice Detector</i> is intended for use in the electromagnetic environment specified below. The customer or the user of Jaundice Dectetor should assure that it is used in such an environment.</p>		
Immunity test	IEC 60601 test level	Compliance level
<p>Conducted RF IEC 61000-4-6</p>	<p>$3V_{rms}$ 150 kHz to 80 MHz</p> <p>$6 V_{rms}$ 150 kHz to 80 MHz in ISM bands</p>	<p>$3 V_{rms}$</p> <p>$6 V_{rms}$</p>
<p>Radiated RF IEC 61000-4-3</p>	<p>$3 V/m$ 80 MHz to 2.7 GHz</p>	<p>$3V/m$</p>
<p>NOTE 1: At 80 MHz and 800 MHz, the higher frequency range applies.</p> <p>NOTE 2: These guidelines may not apply in all situations. Electromagnetic propagation is affected by absorption and reflection from structures, objects and people.</p>		

^a The ISM(industrial, scientific and medical) bands between 150kHz and 80MHz are 6.765MHz to 6.795MHz; 13.553 MHz to 14.567 MHz; 26.957 MHz to 27.283 MHz; and 40.66 MHz to 40.70 MHz.

^b The compliance levels in the ISM frequency bands between 150kHz and 80MHz and in the frequency range 80 MHz to 2.5GHz are intended to decrease the likelihood that mobile/portable communications equipment could cause interference if it is inadvertently brought into patient areas. For this reason, an additional factor of 10/3 is used in calculating the recommended separation distance for transmitters in these frequency ranges.

^c Field strengths from fixed transmitters, such as base stations for radio (cellular/cordless) telephones and land mobile radios, amateur radio, AM and FM radio broadcast and TV broadcast cannot be predicted theoretically with accuracy. To assess the electromagnetic environment due to fixed RF transmitters, an electromagnetic site survey should be considered. If the measured field strength in the location in which the *Jaundice Detector* is used exceeds the applicable RF compliance level above, the *Jaundice Detector* should be observed to verify normal operation. If abnormal performance is observed, additional measures may be necessary, such as reorienting or relocating the *Jaundice Detector*.

^d Over the frequency range 150 kHz to 80 MHz, field strengths should be less than 10 V/m.

**Guidance and manufacturer’s declaration – electromagnetic immunity
–for all EQUIPMENT and SYSTEMS**

**IMMUNITY to proximity fields from RF wireless communications
equipment**

The ENCLOSURE PORT of ME EQUIPMENT and ME SYSTEMS shall be tested as specified in Table 9 using the test methods specified in IEC 61000-4-3.

**Table 9 – Test specifications for ENCLOSURE PORT IMMUNITY to
RF wireless communications equipment**

Test frequency (MHZ)	Band ^{a)} (MHZ)	Service ^{a)}	Modulation ^{b)}	Maximum Power (W)	Distance (m)	Immunity test level (v/m)
385	380-390	TETRA400	Pulse modulation ^{b)} 18 Hz	1,8	0,3	27
450	430-470	GMRS 460, FRS 460	FM ^{c)} ±5 kHz deviation 1 kHz sine	2	0,3	28
710	704-787	LTE Band13,17	Pulse modulation ^{b)} 217Hz	0,2	0,3	9
745						
780						
810	800-960	GSM800/900, TETRA 800,iDEN 820,CDMA 850,LTE Band 5	Pulse modulation ^{b)} 18 Hz	2	0,3	28
870						
930						

Test frequency (MHZ)	Band ^{a)} (MHZ)	Service ^{a)}	Modulation ^{b)}	Maximum Power (W)	Distance (m)	Immunity test level (v/m)
1720	1700-1990	GSM 1800;CDMA 1900;GSM 1900;DECT;LTE Band 1, 3,4, 25; UMTS	Pulse modulation ^{b)} 217 Hz	2	0,3	28
1845						
1970						
2450	2400-2570	Bluetooth, WLAN, 802.11 b/g/n, RFID 2450, LTE Band 7	Pulse modulation ^{b)} 217 Hz	2	0,3	28
5240	5100-5800	WLAN 802.11a/n	Pulse modulation ^{b)} 217 Hz	0,2	0,3	9
5500						
5785						

NOTE If necessary to achieve the IMMUNITY TEST LEVEL, the distance between the transmitting antenna and the ME EQUIPMENT or ME SYSTEM may be reduced to 1m. The 1m test distance is permitted by IEC 61000-4-3.

^{a)} For some services, only the uplink frequencies are included.

^{b)} The carrier shall be modulated using a 50% duty cycle square wave signal.

^{c)} As an alternative to FM modulation, 50% pulse modulation at 18Hz may be used because while it does not represent actual modulation, it would be worst case.

APPENDIX B REPORT OF CLINICAL TRIAL

RESULTS

To verify the availability of the BM-100A Transcutaneous Jaundice Detector, the correlation between instrument measurements (TcB: Transcutaneous Bilirubin) and TSB: Total Serum Bilirubin obtained from blood sampling was tested in the hospital.

Relationship between serum bilirubin measurements (TSB) and Transcutaneous Jaundice Detector measurements (TcB_{anterior chest})

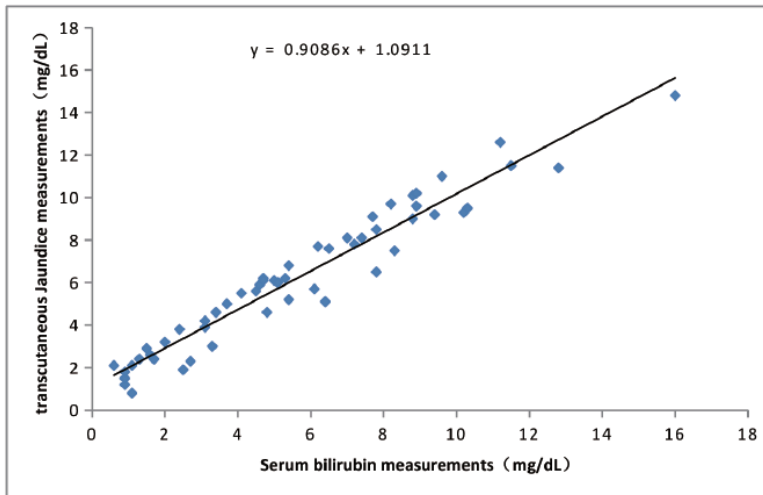

The data showed that the measured serum bilirubin (TSB) was linearly correlated with the measured TcB anterior chest, and the standard error of the linear regression line (δ^*) was ± 0.83 .

*: The standard error (δ) is ± 0.83 , indicating that about 65% of the data obtained from the in vivo measurements are within this range.

Relationship between serum bilirubin measurements (TSB) and Transcutaneous Jaundice Detector measurements (TcB_{forehead})

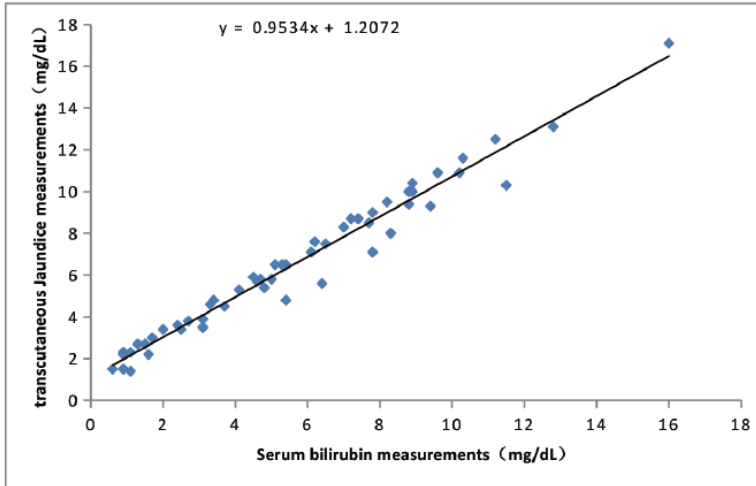

The data showed that the measured serum bilirubin (TSB) and the measured TcB forehead were linearly correlated within the measurement range, and the standard error of the linear regression line (δ^*) was ± 0.62 .

*: The standard error (δ) of ± 0.62 indicates that 81% of the data obtained from the in vivo measurements are within this range.

SPECIAL STATEMENT: All of the content in the manual is checked carefully, if there is any error or content of printing misunderstanding, our company retains finally explanation of this card-usage.

NOTE: The product's appearances maybe differ from the one in this manual, but it does not affect the capability of product. Please understand if it brings you troubles.

NINGBO DAVID MEDICAL DEVICE CO., LTD.

ADD: NO. 2, KEYUAN ROAD, SHIPU SCIENCE AND TECHNOLOGY PARK, XIANGSHAN, 315731

NINGBO, ZHEJIANG PROVINCE, PEOPLE'S REPUBLIC OF CHINA

FAX: +86-574-65962111

MARKETING CENTER: BLDG NO 5. NINGBO SMART PARK, #98 CHUANGYUAN ROAD, YINZHOU

DISTRICT, NINGBO, CHINA 315048

FAX: +86-574-87801111, 87803714

TEL: +86-574-87800008, 87800007

E-MAIL:sales@nbdavid.com

WEBSITE: <https://www.nbdavid.com/en/>

EUROPEAN REPRESENTATIVE: SHANGHAI INTERNATIONAL HOLDING CORP. GMBH (EUROPE)

ADD: EIFFESTRASSE 80, 20537 HAMBURG, GERMANY

TEL: +49-40-2513175

FAX: +49-40-255726

EDITION/REVISION A/4

DATE OF ISSUE 2023/04